

# Saddles Fluted Tops

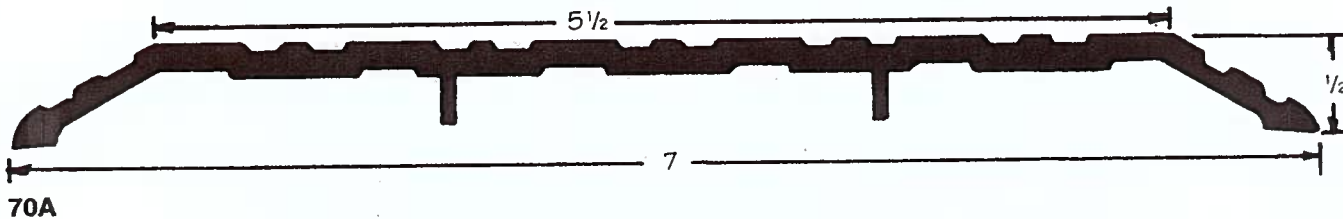

Available with  
1/2" Abrasive Strips

Threshold  
Stop

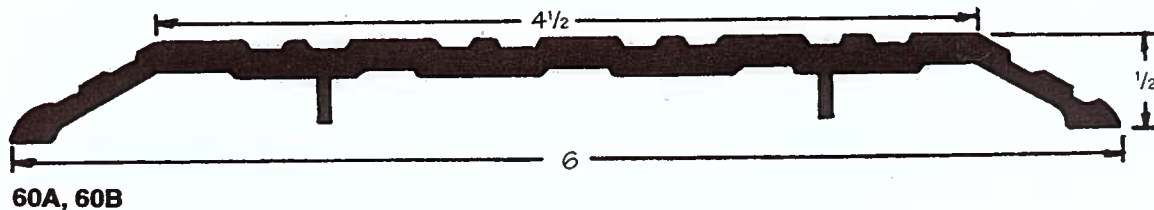
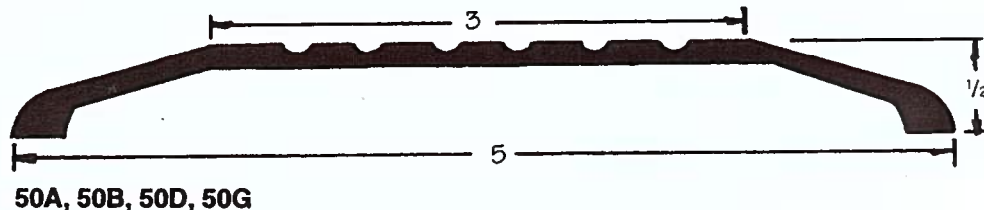
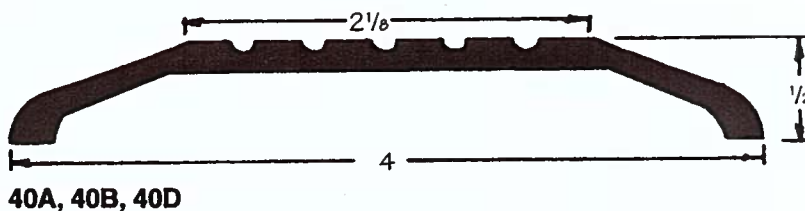
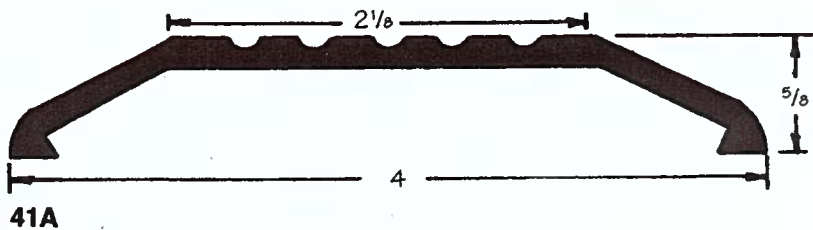
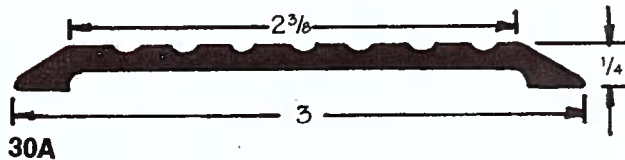
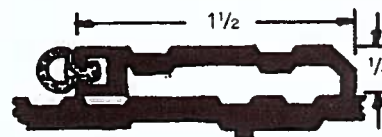

## MATERIAL DESIGNATIONS

A Aluminum	B Bronze	B Architectural Bronze	D Dark Brown Anodized or Paint
E EPDM-Rubber Polymer	F Felt	G Gold	N Solid or Closed Cell Neoprene
P Pile	SS Stainless Steel	V Vinyl	Z Zinc

# Combination Saddle

44AV 44GV (Shown 1/2 of actual size)

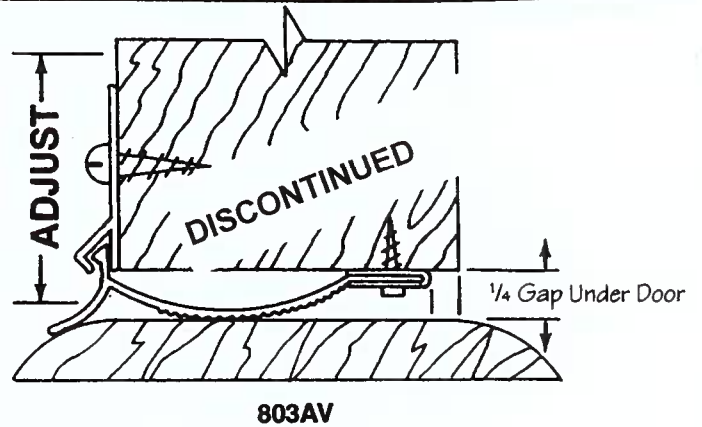
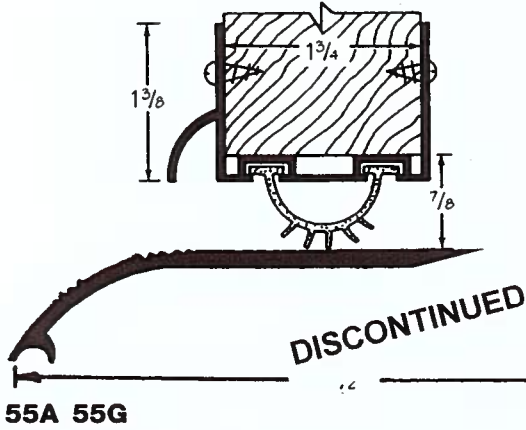

**Special Vinyl  
Door Bottom**

## Saddles Plain Tops



**Available with  
1/2" Abrasive Strips**

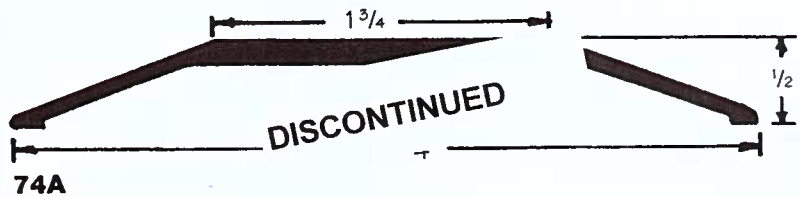
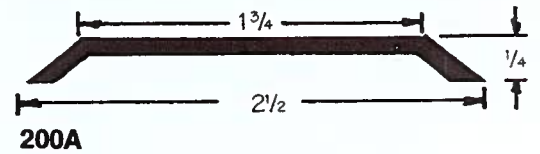

## Sill Extensions

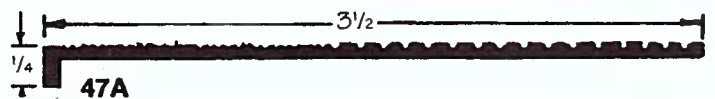
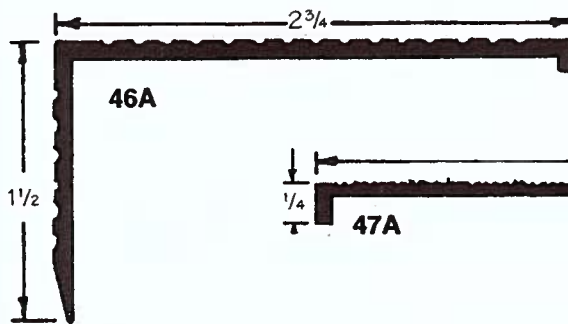
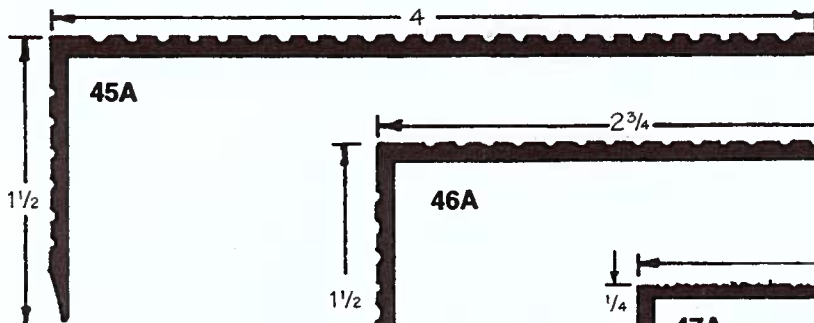

### MATERIAL DESIGNATIONS

- |                       |                    |                        |                                 |
|-----------------------|--------------------|------------------------|---------------------------------|
| A Aluminum            | B Bronze           | B Architectural Bronze | D Dark Brown Anodized or Paint  |
| E EPDM-Rubber Polymer | F Felt             | G Gold                 | N Solid or Closed Cell Neoprene |
| P Pile                | SS Stainless Steel | V Vinyl                | Z Zinc                          |