

Overhead Doors

Panel

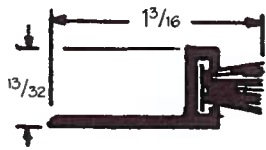

599AP

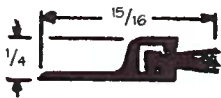

99AP

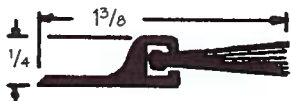

23ANY



299E

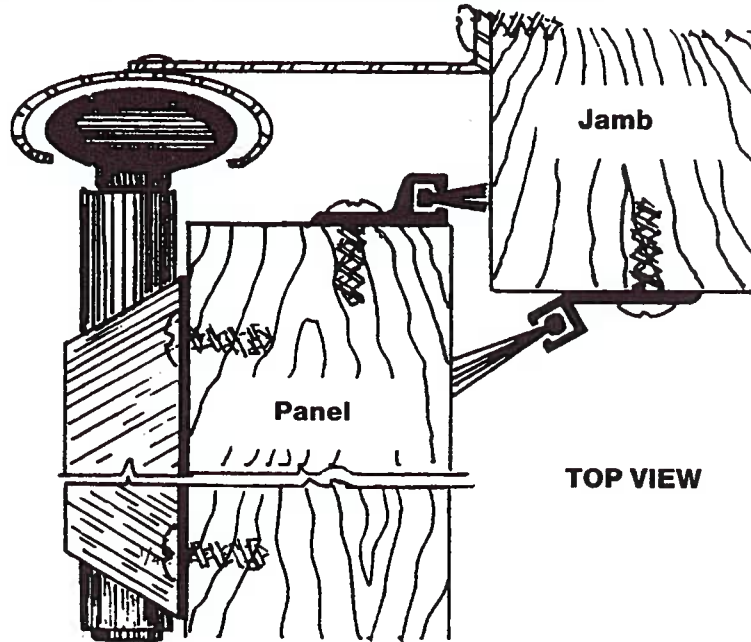

Typical Garage Door Application

Jamb

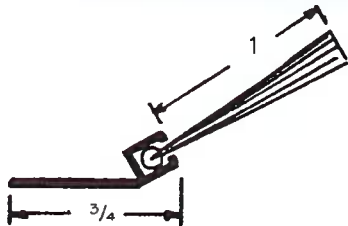

108ANY, 108ADNY

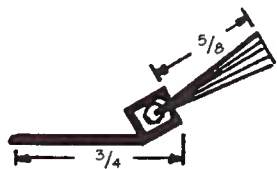

108ANY, 108ADNY



299KV 299KDV

Door Cap

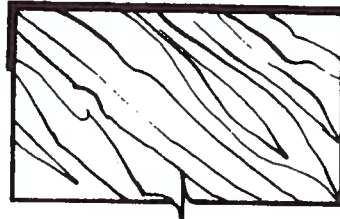

140Z 1 3/4 140B 1 3/4

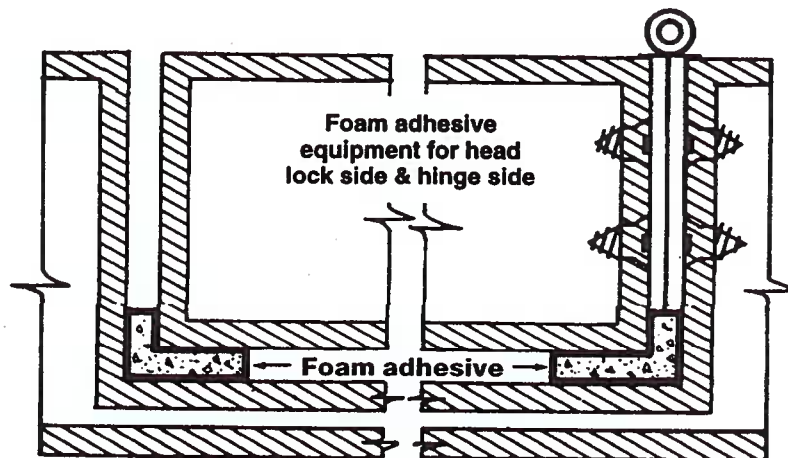

**1/4 X 1/2 3/16 X 3/8
UT Foam**

MATERIAL DESIGNATIONS

A Aluminum	B Bronze	B Architectural Bronze	D Dark Brown Anodized or Paint
E EPDM-Rubber Polymer	F Felt	G Gold	N Solid or Closed Cell Neoprene
P Pile	SS Stainless Steel	V Vinyl	Z Zinc